

GDOL1;GDOP1

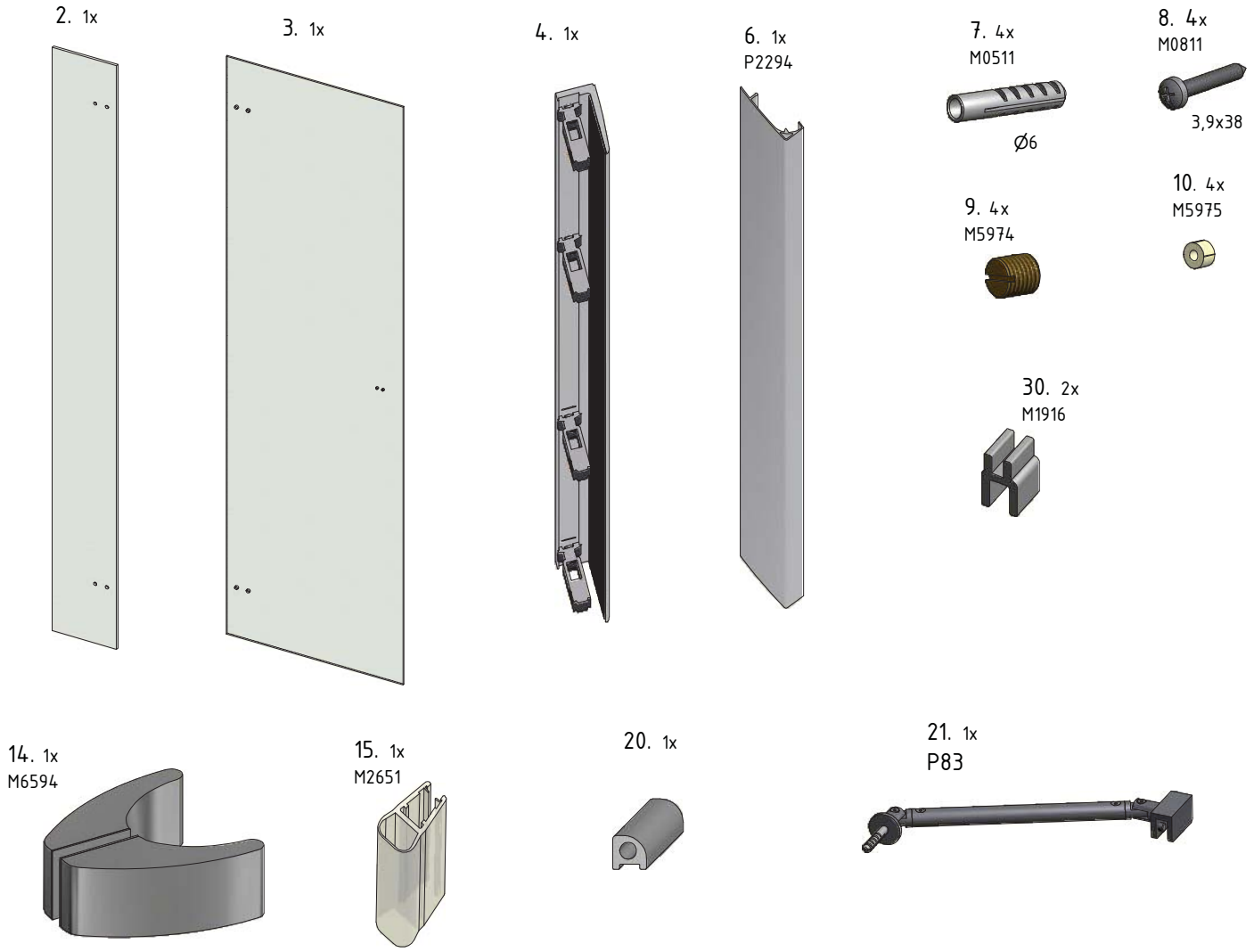

GDOL1

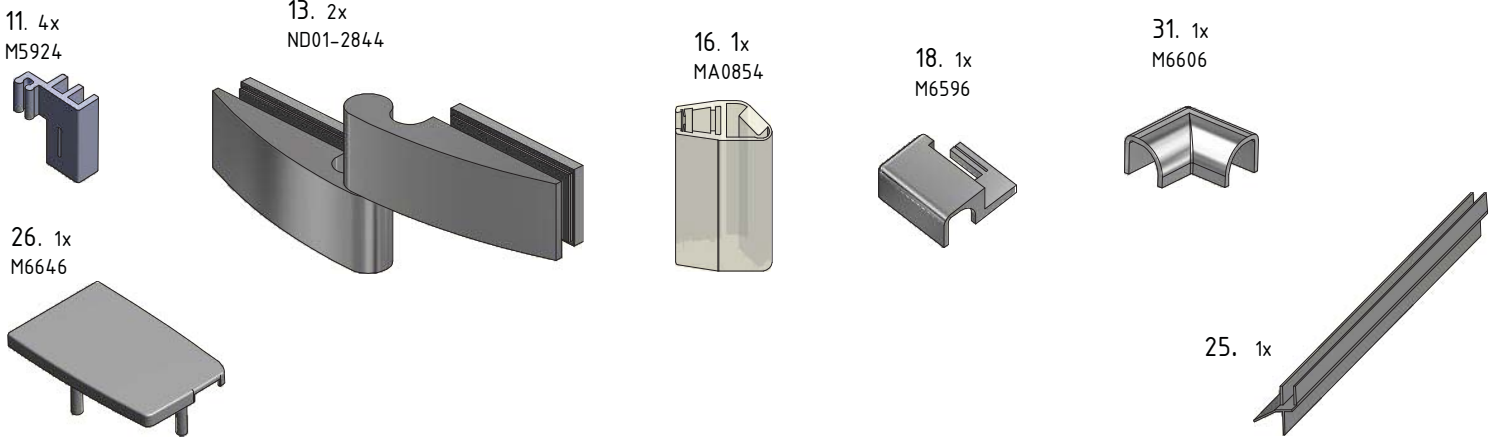

GDOP1

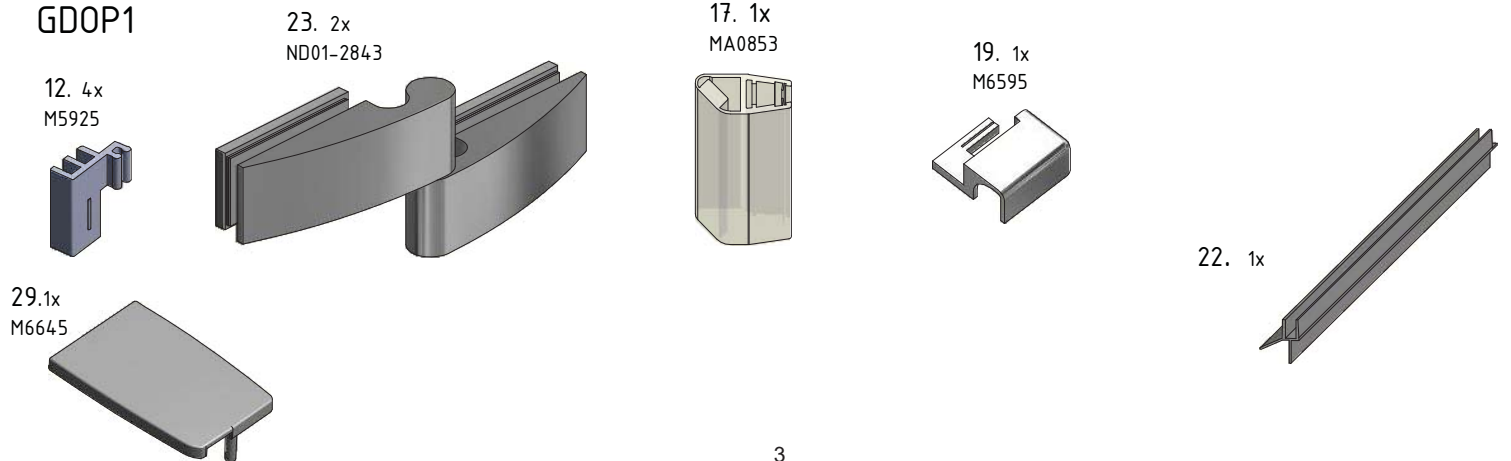

GDOL1

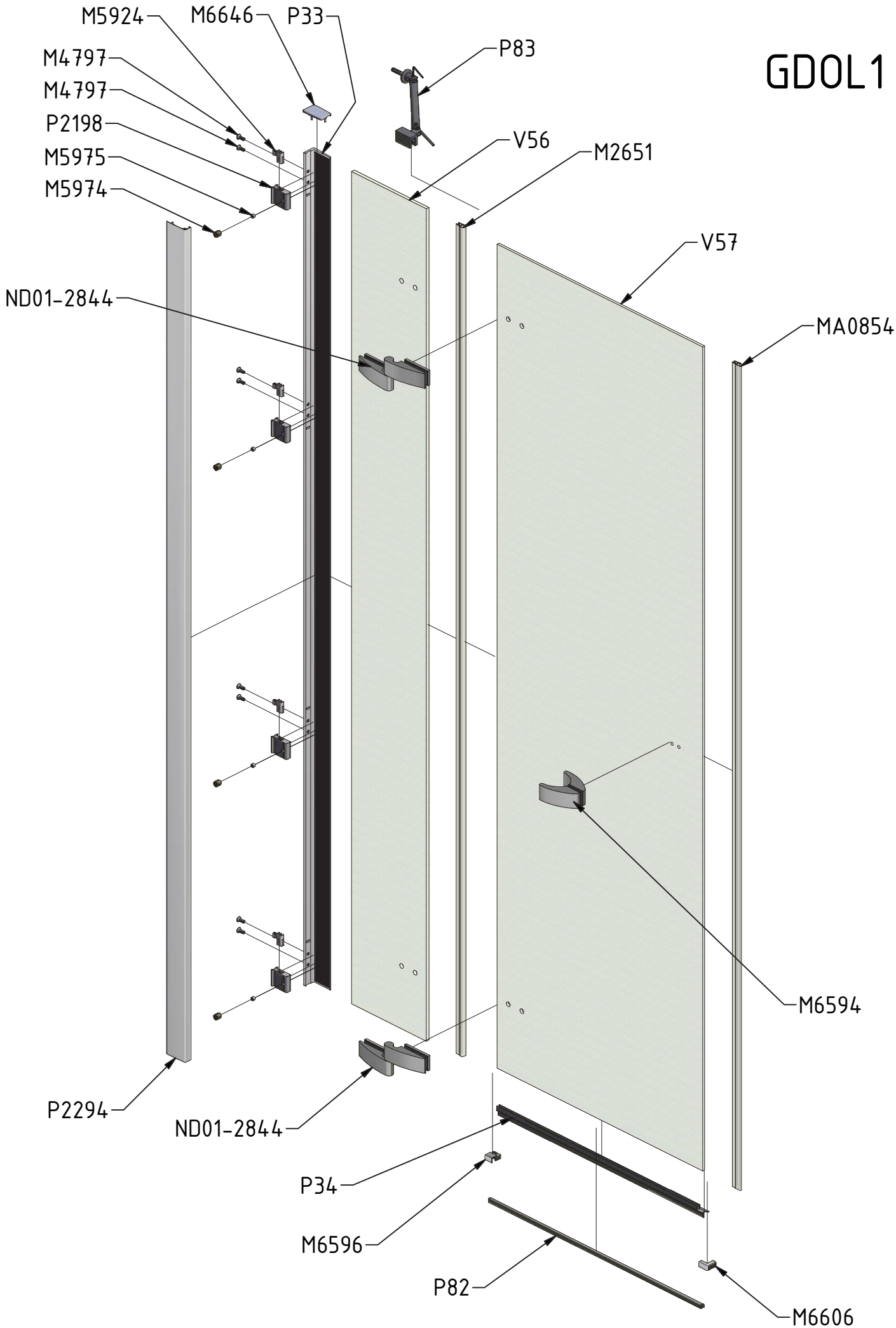

GDOP1

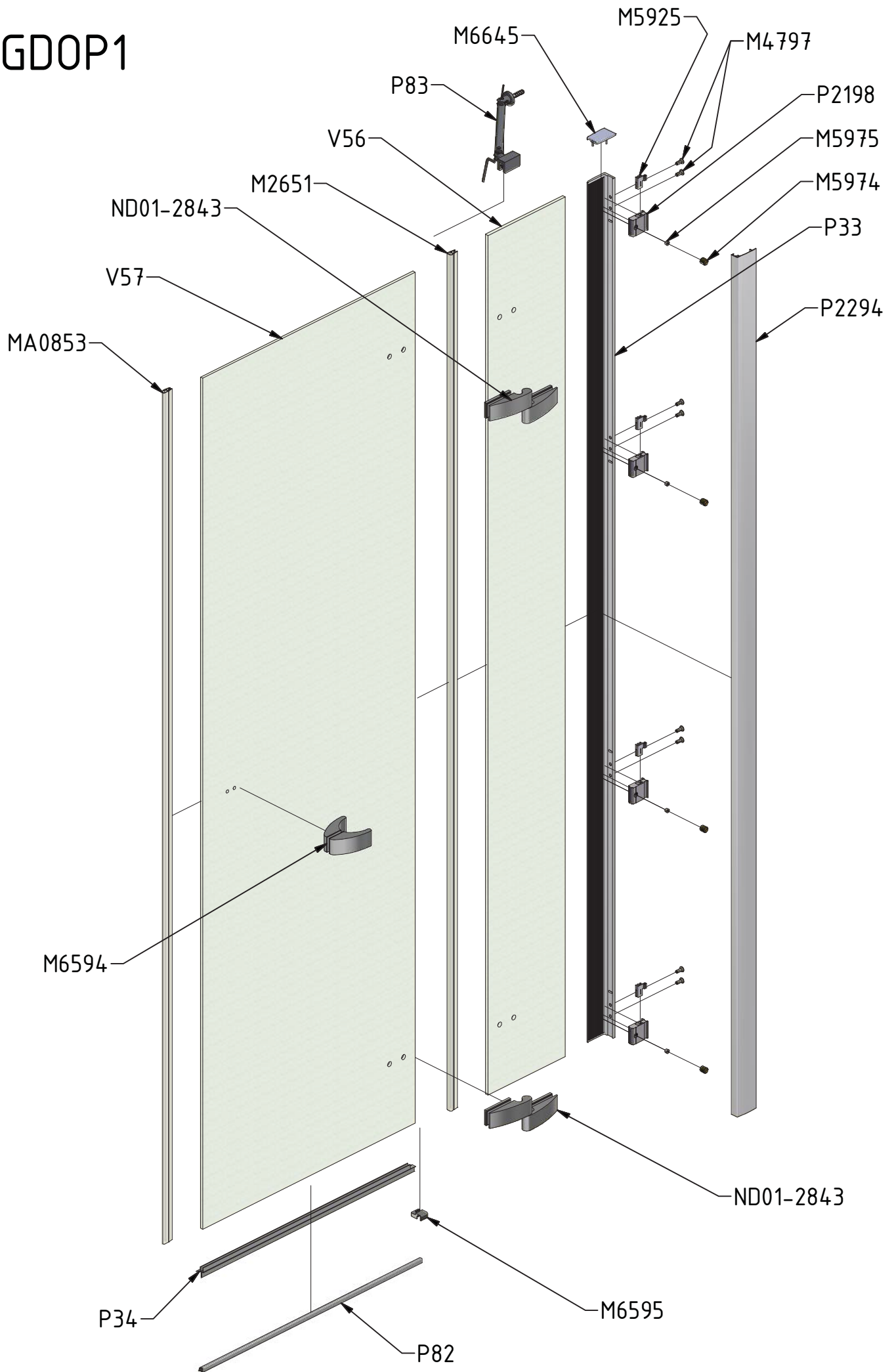

P33			ND01-0973-00
P34			ND01-2420
P82	800		ND01-2424-8
	900		ND01-2424-9
	1000		ND01-2424-9
	1100		ND01-2424-11
	1200		ND01-2424-11
	1300		ND01-2424-13
	1400		ND01-2424-13
	1500		ND01-2424-15
P83	800;900;1000;1100		M8018
	1200;1300;1400;1500		M8019

V56	800	clear glass	ND03-0278-00-02
	900		ND03-0278-00-02
	1000		ND03-0279-00-02
	1100		ND03-0279-00-02
	1200		ND03-0346-00-02
	1300		ND03-0346-00-02
	1400		ND03-0404-00-02
	1500		ND03-0404-00-02
V57	800	clear glass	ND02-0334-00-02
	900		ND02-0335-00-02
	1000		ND02-0335-00-02
	1100		ND02-0549-00-02
	1200		ND02-0549-00-02
	1300		ND02-0550-00-02
	1400		ND02-0550-00-02
	1500		ND02-0551-00-02