

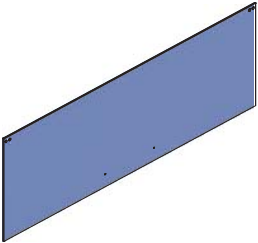









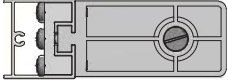
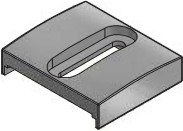
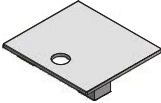







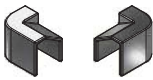



HI 2B2

| POS. | PREVIEW | PCS | SPARE PART |
|------|---|--------------|------------|
| 1 |  | 2 | V283 |
| 2 |  | 2 | ND01-4001 |
| 3 |  | 2 | ND01-4000 |
| 4 |  | 2 | ND01-4005 |
| 5 |  | 2 | ND01-4005 |
| 6 |  | 2 | ND01-4005 |
| 7 |  | 8 | ND01-4005 |
| 8 |  | 6 | ND01-4005 |
| 9 |  | 4 | ND01-4005 |
| 10 |  | 6 | ND01-4005 |
| 11 |  | 2 | ND01-4005 |
| 12 |  | 1 | ND01-4005 |
| 13 |  | 1+1 (SET) | ND01-4005 |
| 14 |  | 1 | ND01-4005 |
| 15 |  | 2 | ND01-3996 |
| 16 |  | 2 | ND01-3997 |

HI 2B2

| POS. | PREVIEW | PCS | SPARE PART |
|------|---|--------------|------------|
| 17 |  | 1 | ND01-4002 |
| 18 |  | 2 | ND01-4003 |
| 19 |  | 1+1 (SET) | ND01-4004 |
| 20 |  | 2 | ND01-3999 |
| 21 |  | 2 | ND01-3999 |
| 22 |  | 2 | ND01-3999 |
| 23 |  | 2 | ND01-3999 |
| 24 |  | 2 | ND01-3999 |
| 25 |  | 1 | - |

ND01-4005

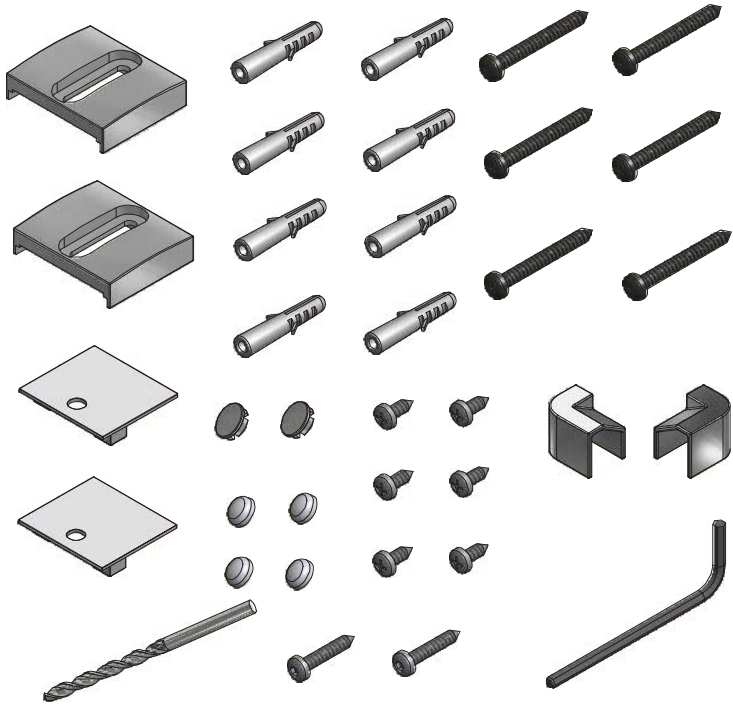

ND01-3996

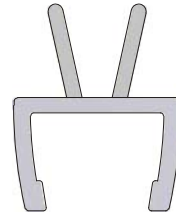

ND01-3997

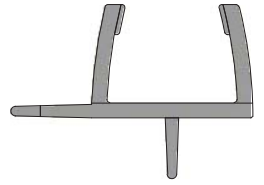

ND01-4004

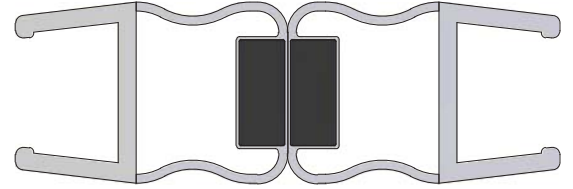

ND01-3999

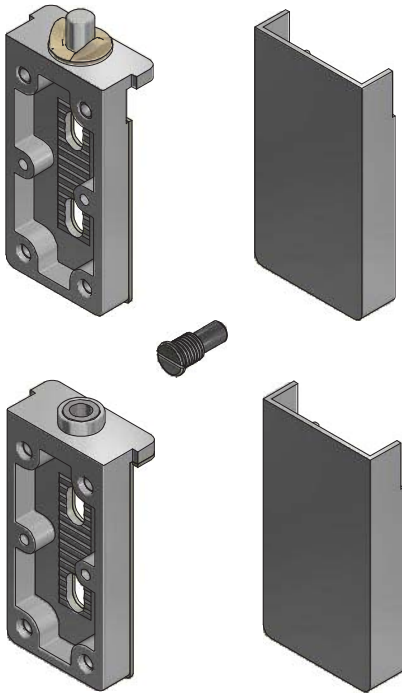

ND01-4000

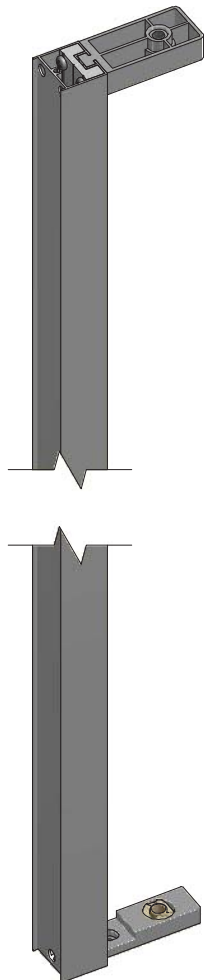

ND01-4001

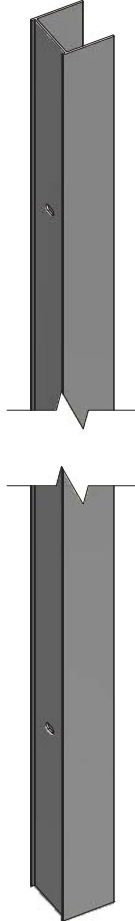

ND01-4002

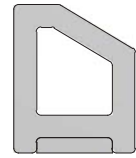

V283

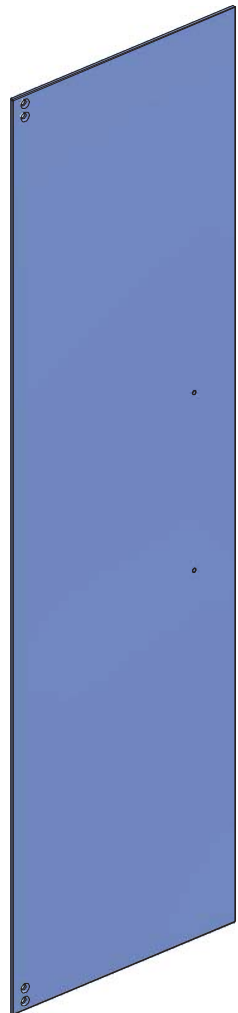

ND01-4003

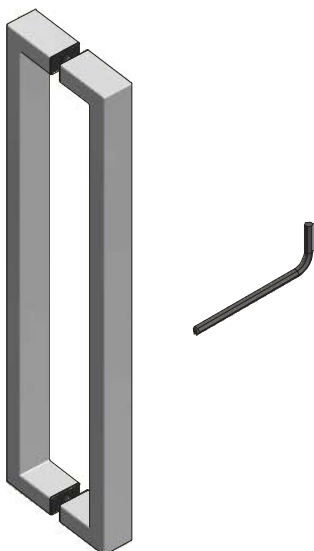

| | | | |
|------|------|-------------|--------------|
| V283 | 800 | Transparent | ND02-0897-02 |
| | 900 | | ND02-0898-02 |
| | 1000 | | ND02-0899-02 |
| | 1200 | | ND02-0900-02 |