

SCREEN MINI

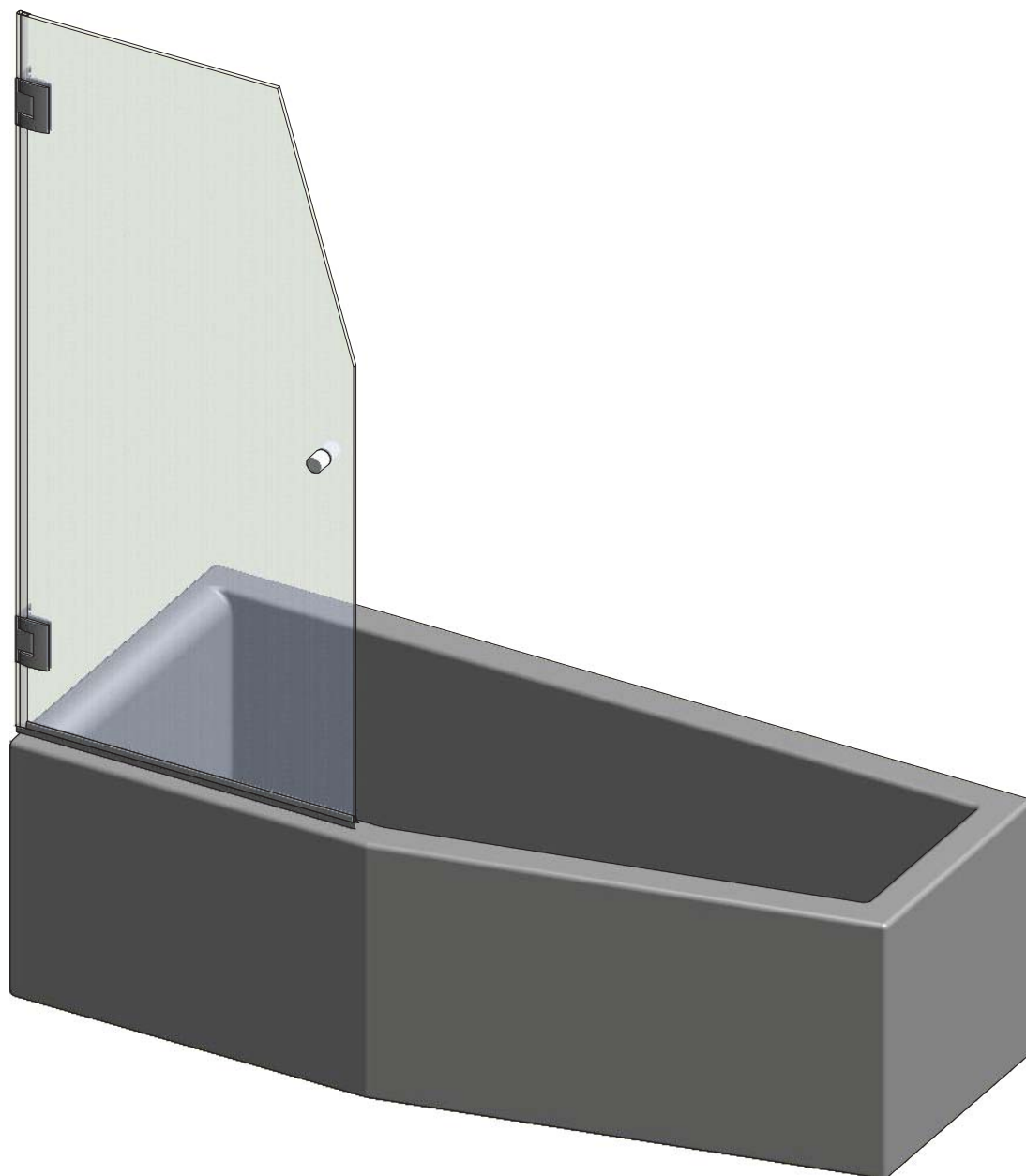

1. 1x
ND01-1521

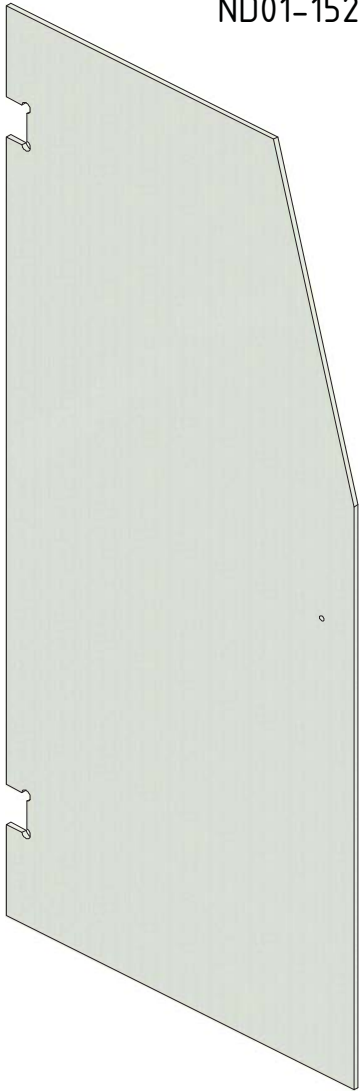

2. 2x
M6721

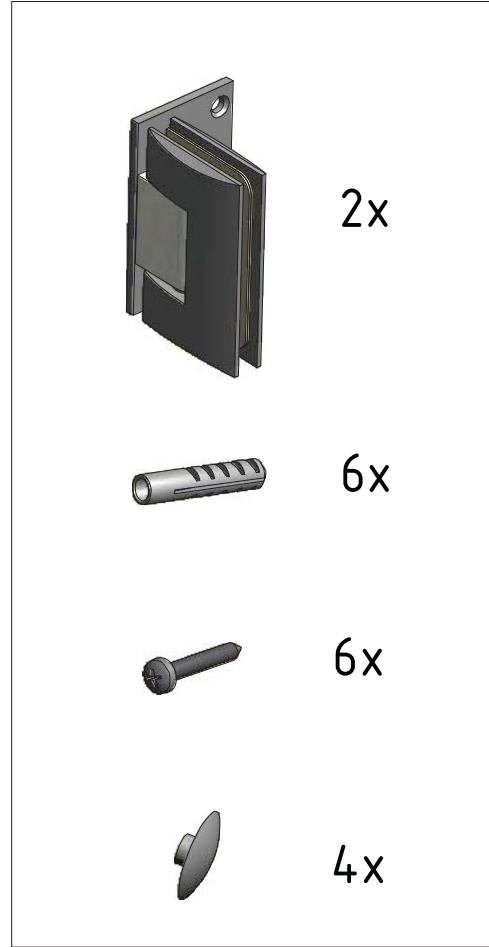

3. 1x
M4650



4. 2x
ND01-3335

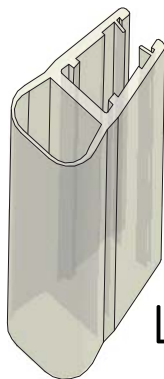

L=125mm

5. 1x
ND01-3336

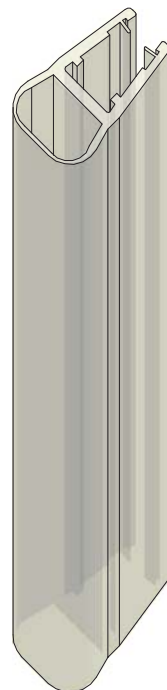

L=960mm

6. 1x
ND01-2818

